



Enidine Rate Controls are designed to regulate the speed and time required for a mechanism to move from one position to another. Adjustable and non-adjustable models are available to accommodate a wide variety of motion control applications. Both single and double acting hydraulic damper designs allow smooth, controllable machine operation by providing rate control for both linear and rotational (hinged) loads. Each product family offers a variety of stroke lengths from which to choose.

Adjustable, Double Acting (ADA 500 and ADA 700 Series) rate controls regulate speed in both tension and/or compression modes independently. ADA products let the user adjust the rate to suit specific application requirements. Fixed orifice interchangeable cartridges are available for the ADA 500 Series, which provide tamperproof operation once the desired rate has been determined. An optional remote adjustment cable provides adjustment control in otherwise inaccessible locations for the ADA 500 Series.

The **DA Series** are non-adjustable, custom-orificed at factory, double acting rate controls which provide smooth, reliable motion control for high load capacities. Tow Bar (TB) snubbers are specially designed DA's which dampen the abrupt starts and stops of power and free conveying systems.

Features and Benefits

- Extensive product line offers flexibility in both size and load capacities to fulfill a wide range of application requirements.
- Custom stroke lengths and damping characteristics can be designed to suit your application requirements.
- ISO quality standards result in reliable, long-life operation.
- Incorporating optional fluids can expand the standard operational temperature range from (15°F to 180°F) to (-30°F to 210°F).
- A select variety of surface finishes maintains original quality appearance and provides the longest corrosion resistance protection.
- Special materials and finishes available to meet specific customer requirements.

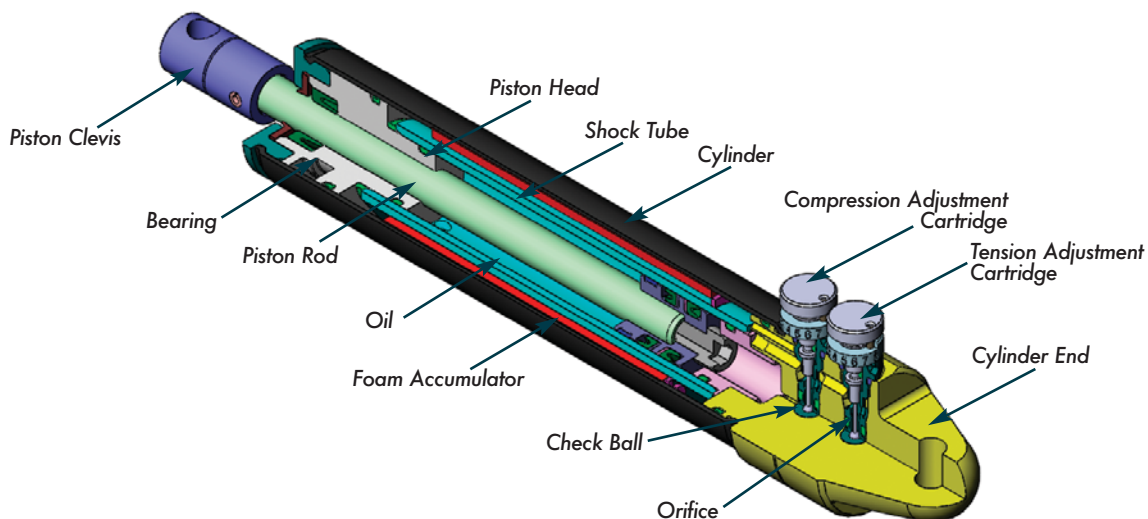

Enidine Double Acting Adjustable (ADA) rate controls control the velocity of both linear and rotational loads throughout their entire motion. Adjustment cartridges on the ADA 500 Series allow flexibility in controlling the speed for an applied force in both the tension and compression directions. Maximum damping is achieved by turning the adjustment knob to the number eight (8) setting, while turning the knob to the zero (0) setting provides minimal resistance. Interchangeable, threaded, fixed-orifice cartridges can provide consistent, tamper-resistant damping to meet particular application requirements.

The ADA 500 Series utilizes two independent adjustment cartridges for motion control in each direction, housed in the cylinder end. The ADA 700 Series has independently controlled tension and compression capabilities located at each end of the unit.

Resistance is controlled by using a wrench key at either end of the rate control and adjusting the movement by following the stiffer (+) or softer (-) indications. When the rate control is compressed, the oil is orificed through the compression adjustment cartridge and flows freely through the tension adjustment cartridge. The tension cartridge check ball unseats and allows free flow of the oil to the rod end of the shock tube. A foam accumulator is utilized to accept the volume of oil displaced by the piston rod. When the rate control is extended, oil is moved through an internal flow path in the shock tube and is orificed through the tension adjustment cartridge. The compression cartridge check ball unseats and allows free flow of the oil into the blind end of the shock tube.

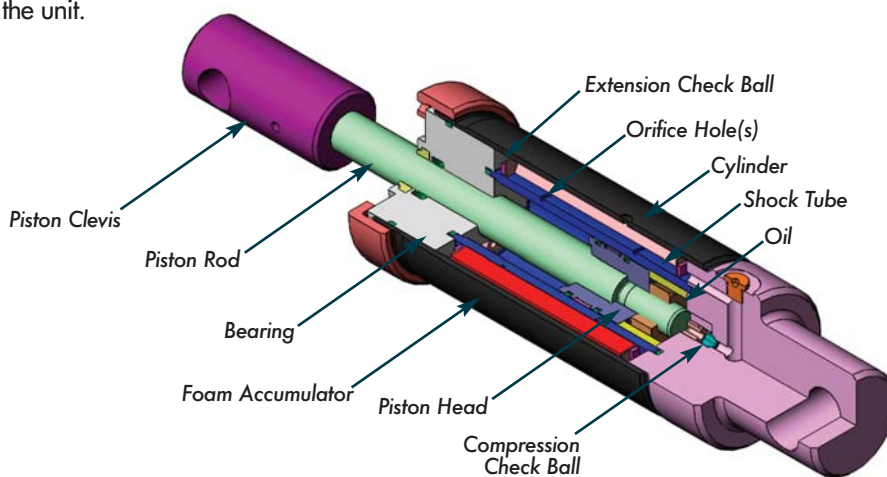

DA Series rate controls are ideally suited for high-energy, heavy load applications requiring rate control in tension, compression or both directions. These non-adjustable, custom-orificed units are designed to specific input conditions, and allow for single and multiple orifice configurations.

Upon compression of the rate control, the compression check ball seats. As the piston head moves, oil is forced through the orifice hole(s) located in the shock tube, producing the required damping force. After the oil has

passed through the orifice hole(s), a portion of the oil passes through the extension check valve and fills the rod end of the shock tube. The remainder of the oil volume displaced by the piston rod compresses the foam accumulator.

Upon extension of the rate control, the extension check ball seats. As the piston head moves, oil is forced through the orifice hole(s) located in the shock tube producing the required damping force. The compression check ball is unseated by the flow of oil which fills the blind end of the shock tube.

Enidine Rate Controls are used to regulate the speed or time required for a mechanism to move from one position to another. They use proven technology to enhance performance in a variety of product applications. Rate controls are typically used to control pneumatic cylinders, linear slides, lids, and other moving mechanisms.

The advantages of using rate controls include:

- 1. Longer Machine Life** – The use of rate controls significantly reduces shock and vibration to machinery caused by uncontrolled machine operation. This further reduces machinery damage, downtime and maintenance costs, while increasing machine life.
- 2. Improved Production Quality** – Harmful effects of uncontrolled motion, such as noise, vibration and damaging impacts, are moderated or eliminated so that production quality is improved.
- 3. Safer Machinery Operation** – Rate controls protect machinery and equipment operators by offering predictable, reliable and controlled machine operation.
- 4. Competitive Advantage** – Machines and end products become more valuable because of increased productivity, longer life, lower maintenance and safer operation.

Enidine offers a wide range of rate controls that provide motion control in tension, compression, or both directions. Adjustable and non-adjustable tamperproof models are available to fit your particular application requirements.

The resisting force provided by Enidine rate controls is typically constant over the entire stroke when the piston rod is moved at a constant velocity, since the rate controls are single orifice products. DA Series models can be custom orificed to provide increasing resisting force over the stroke through the use of multiple orifices in the shock tube. This can be beneficial when controlling the velocity of a lid as it closes, since the torque from the weight of the lid changes as it closes.

Rate Control Adjustment Techniques

A properly adjusted rate control safely controls machinery operation, and reduces noise levels from uncontrolled motion. To correctly adjust the rate control after it has been properly sized for the application, set the adjustment knob (per the useable adjustment setting graphs for the applicable model). Cycle the mechanism and observe the motion of the system.

If the motion of the mechanism is too fast, move the adjustment dial to the next largest number until the desired velocity is achieved.

If the motion of the mechanism is too slow, move the adjustment dial to the next smallest number until the desired velocity is achieved.

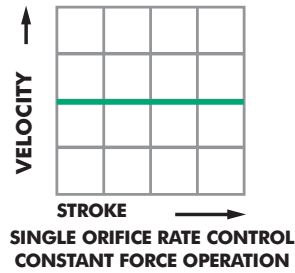

SINGLE ORIFICE RATE CONTROL
CONSTANT FORCE OPERATION

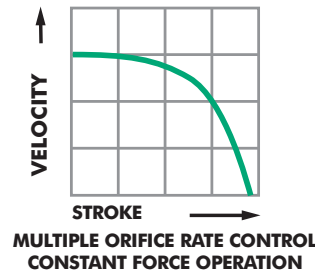

MULTIPLE ORIFICE RATE CONTROL
CONSTANT FORCE OPERATION

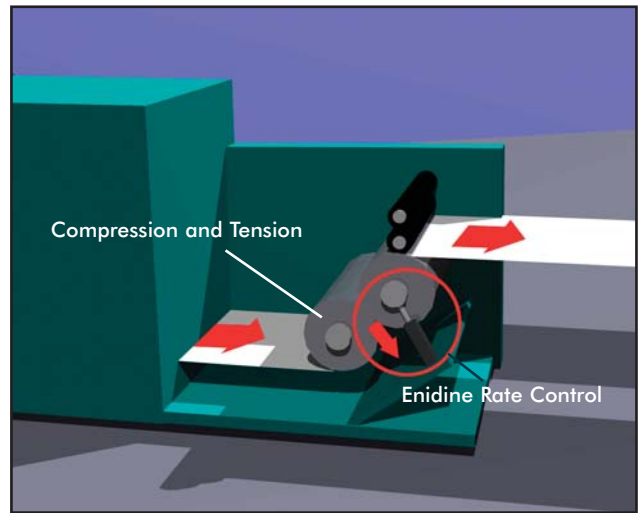

Typical Application: Print Rollers and Paper Tensioners

Useable Adjustment Setting Range

Green lines are model's maximum allowable propelling force.

Compression Mode Adjustment Setting Curve

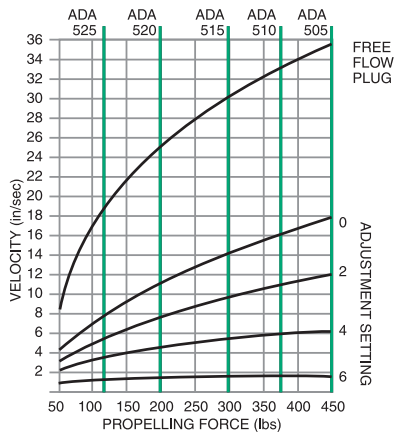

Tension Mode Adjustment Setting Curve

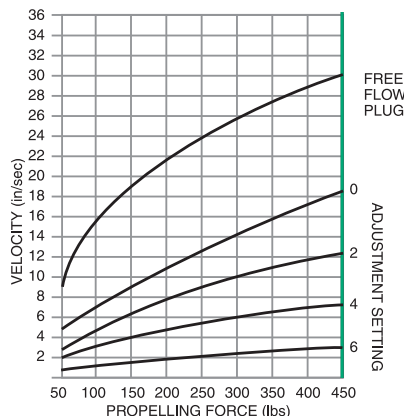

Damping Force



Position 0 provides minimum damping force.
Position 8 provides maximum damping force.
180° adjustment with setscrew locking.

ADA 500

- Determine the damping direction (tension [T], compression [C] or both [T and C]), stroke (in. or mm) required, propelling force (lbs. or N), desired velocity (in./sec. or m/s) and cycles per hour.
 - Calculate total energy per hour (in-lbs./hr or Nm/hr).
 - Compare the damping direction (T, C, or T and C), stroke (in. or mm) required, propelling force (lbs. or N) and total energy per hour (in-lbs./hr or Nm/hr) to the values listed in the Rate Controls Engineering Data charts.
- NOTE:** Propelling force and velocity should be measured at the location of the rate control.
- Determine if adjustable or non-adjustable model is desired.
 - Select the appropriate rate control model.
 - For adjustable rate control models, refer to the Useable Adjustment Settings section for the selected model to determine the proper adjustment setting.
 - For non-adjustable rate control models, refer to the Damping Constant Selection Instructions for the selected model to determine the proper damping constant.

Example:

- Damping Direction (T,C or T and C): T and C
 Stroke (S): 4 in. (102 mm)
 Propelling Force (F_D): 200 lbs. (890 N) (T and C)
 Velocity (V): 8 in./sec. (0.2 m/s)
 Cycles/Hour (C): 20
- Total Energy/Hour: 16,000 in-lbs./hr (1 808 Nm/hr) compression
 16,000 in-lbs./hr (1 808 Nm/hr) tension
 32,000 in-lbs./hr (3 616 Nm/hr) Total
- Compare damping direction (T and C), stroke, propelling force and total energy per hour, to the values listed in the rate controls engineering data charts.
- An adjustable model is desired.
- Selection: ADA 510 (T and C), The proper adjustment is two (2) in tension and compression per the ADA 500 Series Useable Adjustment Setting Range Curves.

After properly sizing the ADA, the adjustment setting can be determined.

- To determine the approximate adjustment setting when the selected model, propelling force, and velocity are known: compare velocity to the propelling force in the compression and/or tension mode adjustment setting curves. The intersection point of the velocity and the propelling force is the approximate adjustment setting to be used. Adjustment higher or lower than this setting will result in slower or faster damper operation, respectively.
- To determine the velocity when the selected model, adjustment setting, and propelling force are known: compare the propelling force to the adjustment setting in the compression and/or tension mode adjustment setting curves. The intersection point of the propelling force and the adjustment setting is the approximate velocity for the selected model. Higher velocities are obtained at lower adjustment settings and lower velocities are obtained at higher adjustment settings.

EXAMPLE: Double Acting Application

- Stroke required: 2 in. (51 mm)
 Control direction: Tension and Compression
 Propelling force: 350 lbs. (1 557 N) (tension),
 400 lbs. (1 780 N) (compression)
- Selection: ADA 505
- Velocity: 11 in./sec. (.28 m/s) (tension),
 6 in./sec. (.15 m/s) (compression)
 Intersection point: Adjustment setting 2 (tension),
 4 (compression)
 - Adjustment setting: 2 (tension), 4 (compression)
 Velocity: 11 in./sec. (.28 m/s) (tension),
 6 in./sec. (.15 m/s) (compression)

NOTE: When a free flow plug is used, the intersection point of the propelling force and free flow plug curve determines the velocity.

NOTE: Propelling force and velocity should be measured at the location of the rate control.

Useable Adjustment Setting Range
Red lines are model's maximum allowable propelling force.

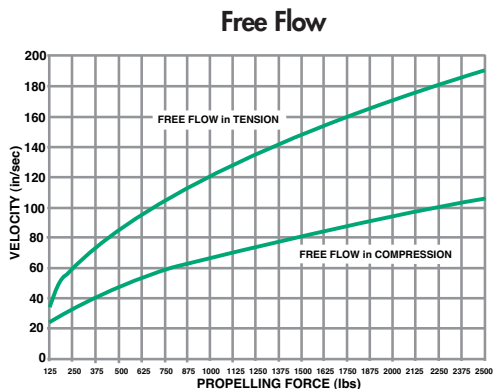
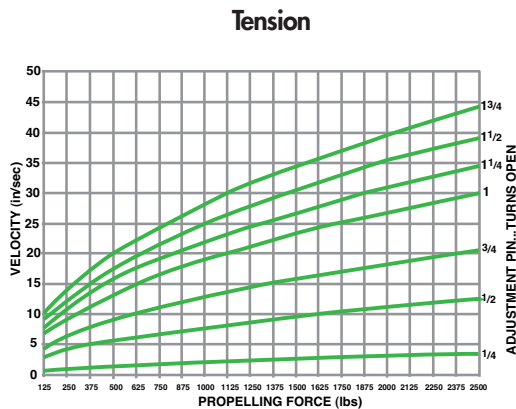
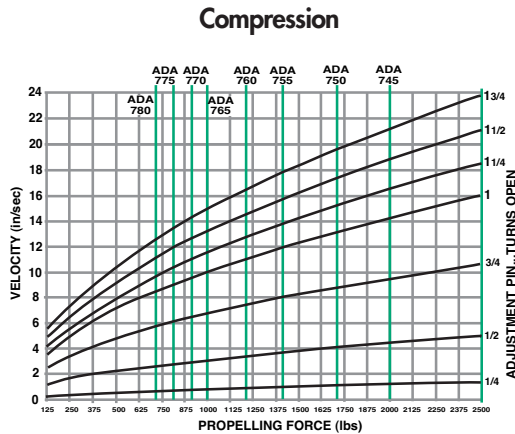

Damping Force



Turn adjustment pin 1 3/4 turns open to provide minimum damping force. Turn adjustment pin fully closed to provide maximum damping force.

1. To determine the approximate adjustment setting, when the selected model, propelling force, and velocity are known, compare velocity to the propelling force in the compression and/or tension mode adjustment setting curves. The intersection point of the velocity and the propelling force is the approximate adjustment setting to be used. Adjustment lower or higher than this setting will result in slower or faster damper operation respectively.
2. To determine the velocity, when the selected model, adjustment setting, and propelling force are known, compare the propelling force to the adjustment setting in the compression and/or tension mode adjustment setting curves. The intersection point of the propelling force and the adjustment setting is the approximate velocity for the selected model. Higher velocities are obtained at higher adjustment settings and lower velocities are obtained at lower adjustment settings.
3. A 1.5mm Hex Wrench (provided) is required to adjust the unit.

NOTE: When a free flow plug is used, the intersection point of the propelling force and free flow plug curve determines the velocity.

EXAMPLE: Adjustable Double Acting Rate Control Application

Stroke required: 6 in. (152 mm)
Control direction: Tension and Compression
Propelling force: 1,000 lbs. (4 4448 N) (tension),
1,625 lbs. (7 228 N) (compression)

Selection: ADA 715
1. Velocity: 25 in./sec. (0,635 m/s) (tension),
4 in./sec. (0,1 m/s) (compression)

Intersection point: Adjustment setting 1 1/2 (tension),
1/2 (compression)

2. Adjustment setting: 1 1/2 (tension), 1/2 (compression)

Velocity: 25 in./sec. (0,635 m/s) (tension),
4 in./sec. (0,1 m/s) (compression)

NOTE: Propelling force and velocity should be measured at the location of the rate control.

Ordering Information/Application Worksheet

ADA Series

Example:

10

Select quantity

ADA 505

Select Catalog No. from Engineering Data chart or Accessory chart

T4

Select Tension Mode
•T Adjustable
•T (0-6) Non-Adjustable*
•P Free Flow

C

Select Compression Mode
•C Adjustable
•C (0-6) Non-Adjustable*
•P Free Flow

*Note: Select adjustment setting (from Adjustment Setting Curve[s]) to be duplicated in non-adjustable cartridge.

DA Series

All DA Models are custom orificed. Application data must be supplied when ordering.

Please provide all application data for unique part number assignment.

Example:

10

Select quantity

DA 50 X 2

Select Catalog No. from Engineering Data chart

APPLICATION DATA

Specify for damping in tension, compression or both, as applicable:

- Vertical, Horizontal or Rotary† Motion
- Propelling Force
- Other (temperature, environmental conditions, etc.)
- Velocity
- Cycles per Hour
- Weight

NOTE: Propelling force and velocity should be measured at the location of the rate control.

Application Worksheet

FAX NO.: _____

DATE: _____

ATTN: _____

COMPANY: _____

The Enidine Application Worksheet makes shock absorber sizing and selection easier.

Fax, phone, or mail worksheet data to Enidine headquarters or your nearest Enidine subsidiary/affiliate or distributor. (See catalog back cover for Enidine locations, or visit www.enidine.com for a list of Enidine distributors.)

Upon Enidine's receipt of this worksheet, you will receive a detailed analysis of your application and product recommendations. (For custom design projects, Enidine representatives will consult with you for specification requirements.)

GENERAL INFORMATION

CONTACT: _____

DEPT/TITLE: _____

COMPANY: _____

ADDRESS: _____

TEL: _____ FAX: _____

EMAIL: _____

PRODUCTS MANUFACTURED: _____

APPLICATION DESCRIPTION

Motion Direction (Check One):

Horizontal Vertical Up Incline Angle _____
 Down Down Height _____

Rotary Horizontal Rotary Vertical Up
 Down

Weight (Min./Max.): _____ (lbs.)/(Kg)

Cycle Rate: _____ (cycles/hour)

Additional Propelling Force (If Known): _____ (lbs.)/(N)

Air Cyl: Bore _____ (in.)(mm) Max. Pressure _____ (psi)(bar) Rod Dia. _____ (in.)(mm)

Hydraulic Cyl: Bore _____ (in.)(mm) Max. Pressure _____ (psi)(bar)
Rod Dia. _____ (in.)(mm)

Motor _____ (hp)(kW) Torque _____ (in.-lbs.)(Nm)

Ambient Temp.: _____ °F (°C)

Environmental Considerations: _____

SHOCK ABSORBER APPLICATION

(All Data Taken at Shock Absorber)

Number Shock Absorbers to Stop Load _____

Impact Velocity (min./max.): _____ (in./sec.)(m/sec.)

Shock Absorber Stroke Requirements: _____ (in.)(mm)

G Load Requirements: _____ (G)(m/sec²)

RATE CONTROL APPLICATION

(All Data Taken at Rate Control)

Number of Rate Controls to Control the Load: _____

Control Direction: Tension (T) Compression (C)

Required Stroke: _____ (in.)(mm) Est. Stroke Time _____ (sec.)

Estimated Velocity at the Rate Control _____ (in./sec.)(m/sec)

ADA 505 → ADA 525 Series

Rate Controls

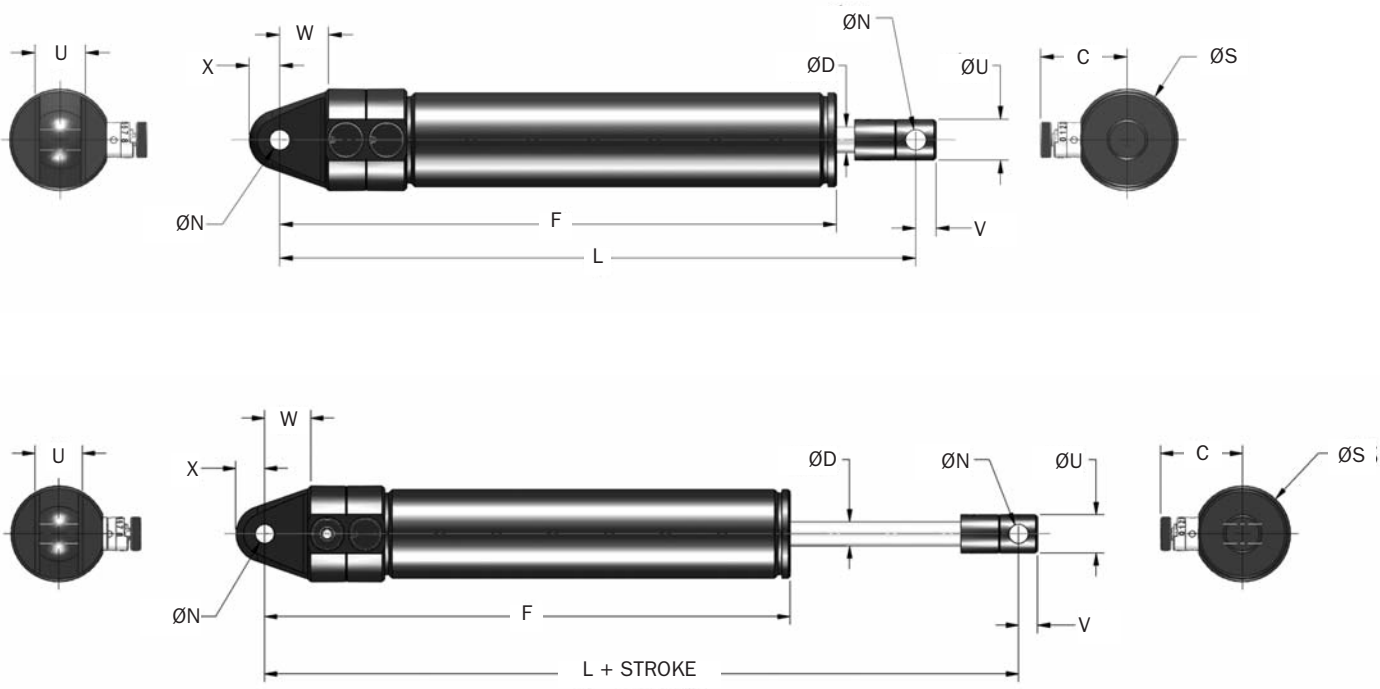

Catalog No./ Model	Damping Direction	Bore Size in. (mm)	(S) Stroke in. (mm)	(F _p) Max. Propelling Force		(E _T C) Max. in.-lbs./hour (Nm/hr)	Model Weight lbs. (Kg)
				Extension lbs. (N)	Compression lbs. (N)		
ADA 505	T, C or T and C	.63	2	450	450	650,000	0.68
ADA 505M		(16,0)	(50,0)	(2 000)	(2 000)	(73 450)	(0,3)
ADA 510	T, C or T and C	.63	4	450	375	850,000	0.80
ADA 510M		(16,0)	(100,0)	(2 000)	(1 670)	(96 050)	(0,372)
ADA 515	T, C or T and C	.63	6	450	300	1,050,000	1.0
ADA 515M		(16,0)	(150,0)	(2 000)	(1 335)	(118 650)	(0,445)
ADA 520	T, C or T and C	.63	8	450	200	1,250,000	1.1
ADA 520M		(16,0)	(200,0)	(2 000)	(900)	(141 250)	(0,520)
ADA 525	T, C or T and C	.63	10	450	125	1,450,000	1.3
ADA 525M		(16,0)	(250)	(2 000)	(550)	(163 850)	(0,590)

Catalog No./ Model	C in. (mm)	D in. (mm)	F in. (mm)	L in. (mm)	N +.005/-0.000 +0.13/-0.00 in. (mm)	S in. (mm)	U +.000/-0.010 +0.00/-0.381 in. (mm)	V in. (mm)	W in. (mm)	X in. (mm)	(S) Stroke in. (mm)	Damping Direction in. (mm)
ADA 505	1.06	.31	6.87	7.81	.251	1.25	.500	.25	.563	.375	2	T, C or T and C
ADA 505M	(27,0)	(8,0)	(173,0)	(200)	(6,0)	(31,8)	(12,7)	(6,3)	(14,2)	(9,5)	(50,0)	
ADA 510	1.06	.31	8.87	9.81	.251	1.25	.500	.25	.563	.375	4	T, C or T and C
ADA 510M	(27,0)	(8,0)	(224,0)	(250)	(6,0)	(31,8)	(12,7)	(6,3)	(14,2)	(9,5)	(100,0)	
ADA 515	1.06	.31	10.87	11.81	.251	1.25	.500	.25	.563	.375	6	T, C or T and C
ADA 515M	(27,0)	(8,0)	(275,0)	(300)	(6,0)	(31,8)	(12,7)	(6,3)	(14,2)	(9,5)	(150,0)	
ADA 520	1.06	.31	12.87	13.81	12.87	1.25	.500	.25	.563	.375	8	T, C or T and C
ADA 520M	(27,0)	(8,0)	(325,0)	(350)	(6,0)	(31,8)	(12,7)	(6,3)	(14,2)	(9,5)	(200,0)	
ADA 525	1.06	.31	14.87	15.81	.251	1.25	.500	.25	.563	.375	10	T, C or T and C
ADA 525M	(27,0)	(8,0)	(376,0)	(400)	(6,0)	(31,8)	(12,7)	(6,3)	(14,2)	(9,5)	(250,0)	

ADA 705 → ADA 735 Series

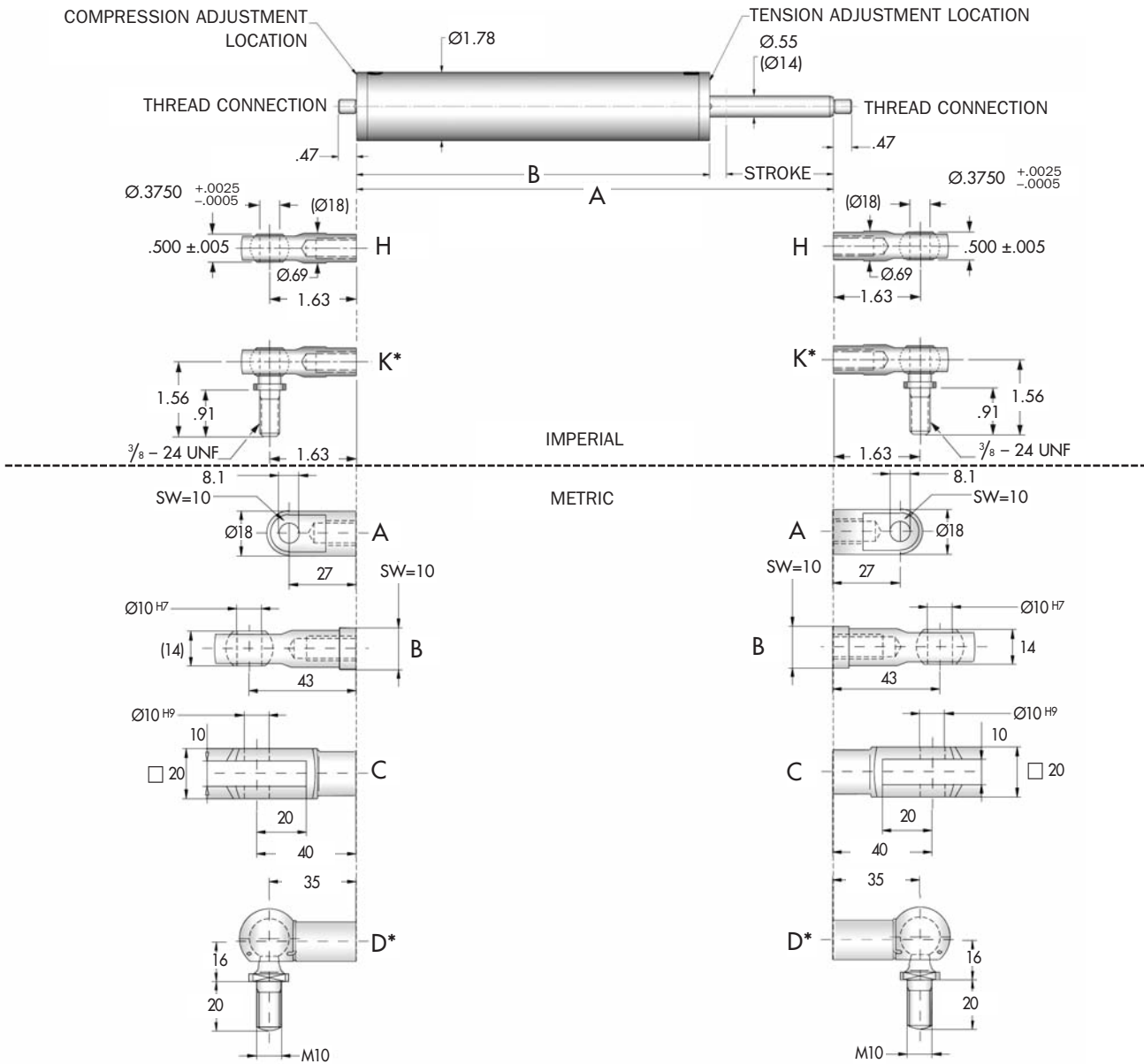

Catalog No./ Model	Damping Direction	Bore Size in. (mm)	(S) Stroke in. (mm)	(F _D) Max. Propelling Force		(E ₁ C) Max in.-lbs./hour (m/s)	Model Weight lbs. (Kg)	A in. (mm)	B in. (mm)
				Tension lbs. (N)	Compression lbs. (N)				
ADA 705	T, C or T and C	.98 (25)	2 (50,0)	2,500 (11 000)	2,500 (11 000)	1,100,000 (129 000)	3.5 (1,6)	9.35 (237)	7.10 (180)
ADA 710	T, C or T and C	.98 (25)	4 (100,0)	2,500 (11 000)	2,500 (11 000)	1,400,000 (168 000)	4.4 (2,0)	13.35 (339)	9.10 (231)
ADA 715	T, C or T and C	.98 (25)	6 (150,0)	2,500 (11 000)	2,500 (11 000)	1,800,000 (206 000)	5.1 (2,3)	17.35 (441)	11.10 (282)
ADA 720	T, C or T and C	.98 (25)	8 (200,0)	2,500 (11 000)	2,500 (11 000)	2,100,000 (247 000)	5.7 (2,6)	21.30 (541)	13.10 (332)
ADA 725	T, C or T and C	.98 (25)	10 (250,0)	2,500 (11 000)	2,500 (11 000)	2,500,000 (286 000)	6.4 (2,9)	25.30 (643)	15.10 (383)
ADA 730	T, C or T and C	.98 (25)	12 (300,0)	2,500 (11 000)	2,500 (11 000)	2,800,000 (326 000)	7.1 (3,2)	29.35 (745)	17.10 (434)
ADA 735	T, C or T and C	.98 (25)	14 (350,0)	2,500 (11 000)	2,500 (11 000)	3,200,000 (366 000)	7.9 (3,6)	33.35 (847)	19.10 (485)

*Notes: 1. The maximum load capacity for mounting option K and D is 650 lbs.
2. The maximum load capacity for mounting option K and D is 1 600 N

ADA 740 → ADA 780 Series

Rate Controls

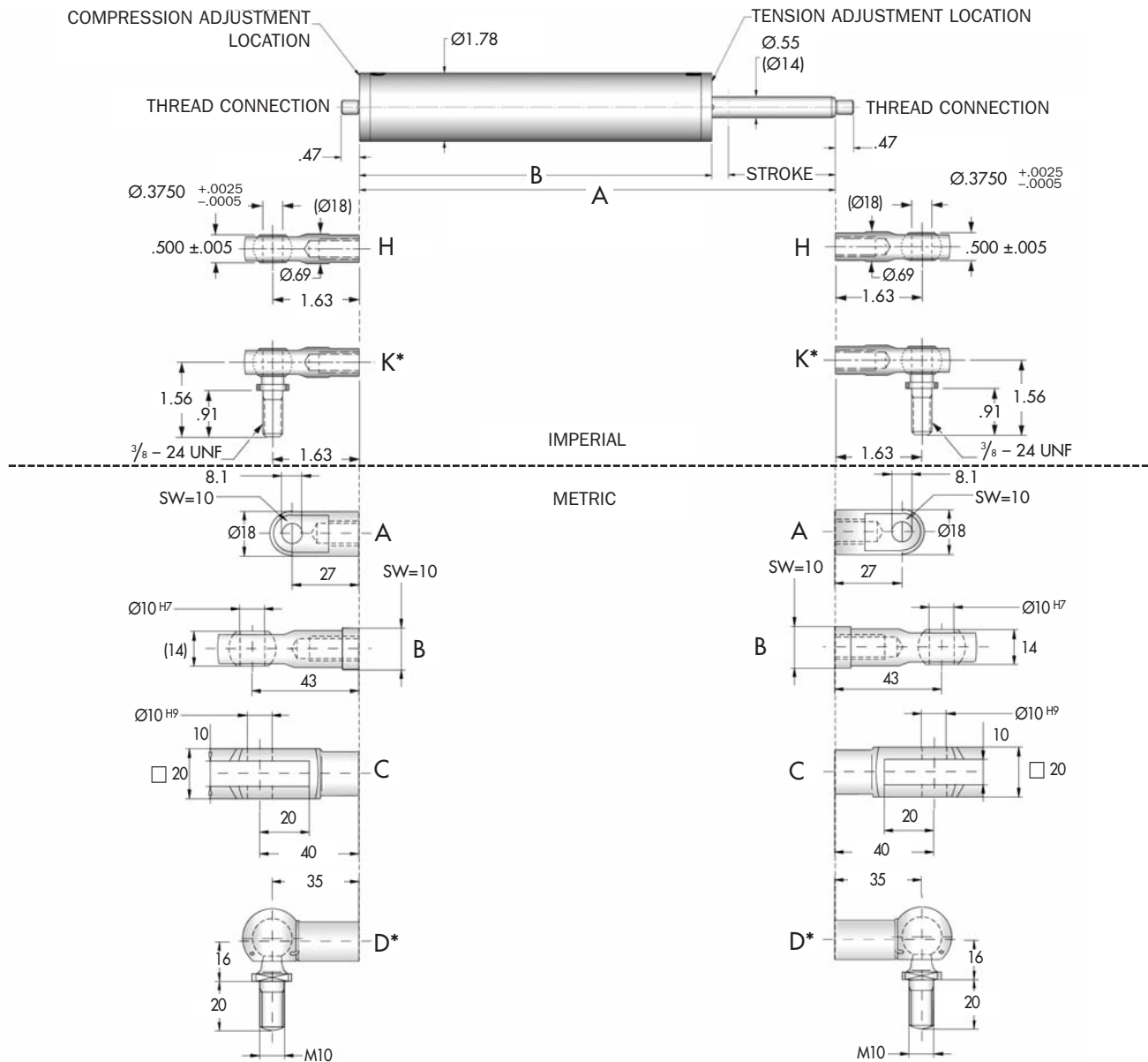

Catalog No./ Model	Damping Direction	Bore Size in. (mm)	(S) Stroke in. (mm)	(F _D) Max. Propelling Force		(E _{T-C}) Max in.-lbs./hour (m/s)	Model Weight lbs. (Kg)	A in. (mm)	B in. (mm)
				Tension lbs. (N)	Compression lbs. (N)				
ADA 740	T, C or T and C	.98 (25,0)	16 (400)	2,500 (11 000)	2,500 (11 000)	3,500,000 (405 000)	8.6 (3,9)	37.30 (947)	21.10 (535)
ADA 745	T, C or T and C	.98 (25,0)	18 (450)	2,500 (11 000)	2,000 (8 800)	3,900,000 (444 000)	9.3 (4,2)	41.30 (1 049)	23.10 (586)
ADA 750	T, C or T and C	.98 (25,0)	20 (500)	2,500 (11 000)	1,700 (7 500)	4,200,000 (484 000)	9.9 (4,5)	45.30 (1 151)	25.10 (637)
ADA 755	T, C or T and C	.98 (25,0)	22 (550)	2,500 (11 000)	1,400 (6 200)	4,600,000 (524 000)	10.6 (4,8)	49.35 (1 253)	27.10 (688)
ADA 760	T, C or T and C	.98 (25,0)	24 (600)	2,500 (11 000)	1,200 (5 300)	4,900,000 (563 000)	11.5 (5,2)	53.35 (1 355)	29.10 (739)
ADA 765	T, C or T and C	.98 (25,0)	26 (650)	2,500 (11 000)	1,000 (4 500)	5,300,000 (603 000)	12.1 (5,5)	57.35 (1 457)	31.10 (790)
ADA 770	T, C or T and C	.98 (25,0)	28 (700)	2,500 (11 000)	900 (4 000)	5,600,000 (642 000)	12.8 (5,8)	61.30 (1 557)	33.10 (840)
ADA 775	T, C or T and C	.98 (25,0)	30 (750)	2,500 (11 000)	800 (3 500)	6,000,000 (681 000)	13.4 (6,1)	65.30 (1 659)	35.10 (891)
ADA 780	T, C or T and C	.98 (25,0)	32 (800)	2,500 (11 000)	700 (3 100)	6,300,000 (721 000)	14.3 (6,5)	69.35 (1 761)	37.10 (942)

*Notes: 1. The maximum load capacity for mounting option for K and D is 650 lbs. 2. The maximum load capacity for mounting option for K and D is 1 600 N.

Remote Adjustment Cable for ADA 500 Series

Enidine will custom fit a remote adjustment cable for applications where the ADA unit will be mounted in non-accessible locations. Contact Enidine for more information.

Note: If rotary application, please complete application worksheet on page 104 and forward to Enidine.

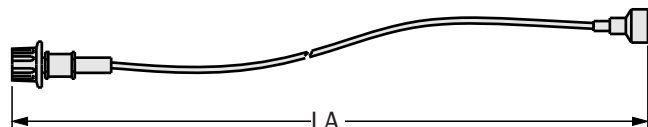

Standard remote adjustment cable length is 48" (1220 mm). Optional lengths available upon request.
Note: Remote adjustment cable can be used in a single position only.

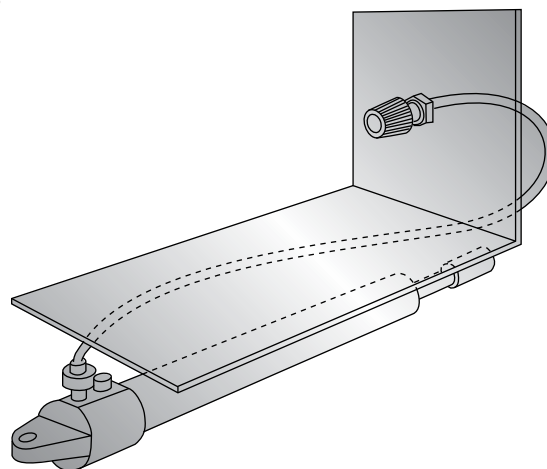

Adjustable Cartridge

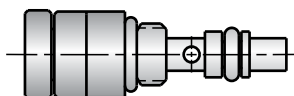

Free Flow Plug

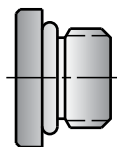

Non-Adjustable Cartridge

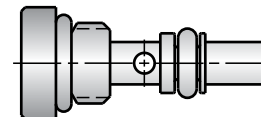

Catalog No.	Part Number	Accessory Description	LA in. (mm)	Weight oz. (g)
RAC48	1K495748	Remote Adjustment Cable	48 (1220)	7 (191)
RAC4957	AJ4957325	Adjustable Cartridge	<p>Notes</p> <p>"x" specify desired setting "0-6". May be used in place of adjustable cartridge.</p> <p>For installing adjustable and non-adjustable cartridges.</p> <p>Provides least amount of damping force for ADA Models.</p>	
NAC "x"	NJ"x"4957327	Non-Adjustable Cartridge (0-6)		
CW4957	2L4957302	Cartridge Wrench		
FFP4957	PA4957326	Free Flow Plug		

DA 50 x 2 → DA 75 x 4 Series

DA 75M x 50 → DA 75M x 100 Series

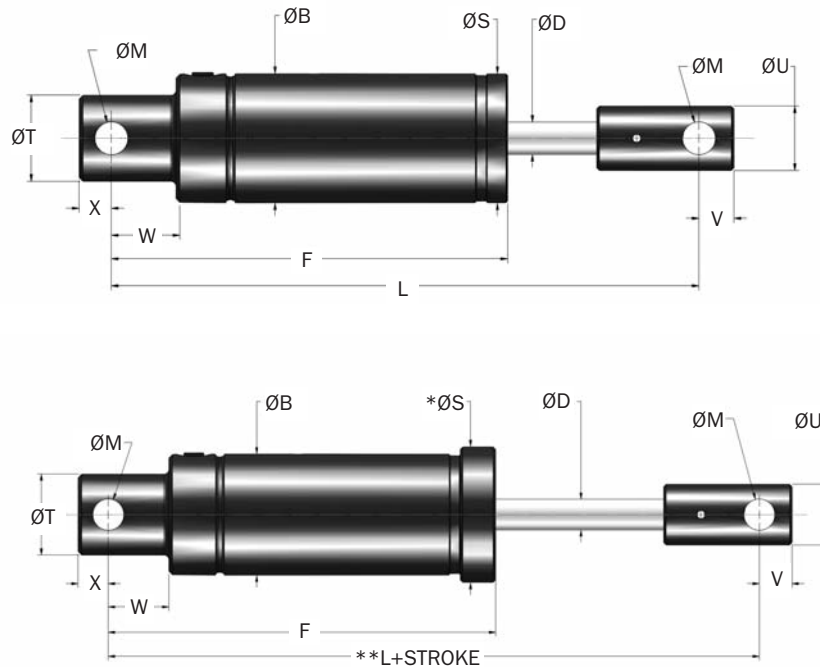

Catalog No./ Model	Damping Direction	Bore Size in. (mm)	(S) Stroke in. (mm)	(F _D) Max. Propelling Force lbs. (N)	(E _T) Max. in.-lbs./cycle (Nm/cycle)	(E _T C) Max. in.-lbs./hr (Nm/cycle)	Model Weight lbs. (Kg)
DA 50 x 2	T, C or T and C	1.13 (28,7)	2 (50,8)	2,500 (11 121)	5,000 (565)	1,400,000 (158 179)	3.5 (1,59)
DA 50 x 4	T, C or T and C	1.13 (28,7)	4 (101,6)	2,500 (11 121)	10,000 (1 120)	1,700,000 (192 074)	5.0 (2,27)
DA 50 x 6	T, C or T and C	1.13 (28,7)	6 (152,4)	2,500 (11 121)	15,000 (1 695)	2,000,000 (225 970)	6.5 (2,95)
DA 50 x 8	T, C or T and C	1.13 (28,7)	8 (203,2)	2,500 (11 121)	20,000 (2 260)	2,300,000 (259 865)	8.0 (3,63)
DA 75 x 2	T, C or T and C	1.50 (38,0)	2 (50,0)	5,000 (22 250)	10,000 (1 120)	2,700,000 (305 000)	25.0 (11,4)
DA 75M x 50							
DA 75 x 4	T, C or T and C	1.50 (38,0)	4 (100,0)	5,000 (22 250)	20,000 (2 240)	3,100,000 (350 000)	29.0 (13,2)
DA 75M x 100							

Catalog No./ Model	B in. (mm)	D in. (mm)	F in. (mm)	L in. (mm)	M ±.015 (±0,38) in. (mm)	S in. (mm)	T ±.015 (±0,38) in. (mm)	U ±.010 (±0,25) in. (mm)	V in. (mm)	W in. (mm)	X in. (mm)	(S) Stroke in. (mm)
DA 50 x 2	2.00 (50,8)	0.56 (14,2)	7.59 (193)	9.98 (253)	.578 (14,7)	2.25 (57,2)	1.50 (38,1)	1.125 (28,6)	.56 (14,2)	1.13 (28,7)	.56 (14,2)	2 (50,8)
DA 50 x 4	2.00 (50,8)	0.56 (14,2)	9.59 (243)	11.98 (304)	.578 (14,7)	2.25 (57,2)	1.50 (38,1)	1.125 (28,6)	.56 (14,2)	1.13 (28,7)	.56 (14,2)	4 (101,6)
DA 50 x 6	2.00 (50,8)	0.56 (14,2)	11.59 (294)	13.98 (355)	.578 (14,7)	2.25 (57,2)	1.50 (38,1)	1.125 (28,6)	.56 (14,2)	1.13 (28,7)	.56 (14,2)	6 (152,4)
DA 50 x 8	2.00 (50,8)	0.56 (14,2)	13.59 (345)	15.98 (406)	.578 (14,7)	2.25 (57,2)	1.50 (38,1)	1.125 (28,6)	.56 (14,2)	1.13 (28,7)	.56 (14,2)	8 (203,2)
DA 75 x 2	3.00 (76,0)	0.75 (19,0)	9.58 (245)	13.75 (348)	.765 (19,4)	3.38 (86,0)	2.00 (51,0)	1.500 (38,0)	.81 (21,0)	1.50 (38,0)	.75 (19,0)	2 (50,0)
DA 75M x 50												
DA 75 x 4	3.00 (76,0)	0.75 (19,0)	11.58 (295)	15.75 (398)	.765 (19,4)	3.38 (86,0)	2.00 (51,0)	1.500 (38,0)	.81 (21,0)	1.50 (38,0)	.75 (19,0)	4 (100,0)
DA 75M x 100												

- Notes: 1. DA Models will function at 10% of their maximum rated energy per cycle. If less than 10%, a smaller model should be specified.
 2. Provide a positive stop 12 in. before end of stroke in tension and compression to prevent internal bottoming.
 3. For optimal performance in vertical applications using compression, mount the rate control with the piston rod down.
 4. * ØS indicates outside diameter of optional protective sleeve for TB models.
 5. ** Dimension L is controlled by a 2.0 in. stroke limiter.

Rate Controls DA Series

Technical Data

DA 75 x 6 → TB 100 x 6 Series

DA 75M x 150 → DA 75M x 250 Series

OPTIONAL PROTECTIVE SLEEVE,
TOW BAR (TB) MODELS ONLY

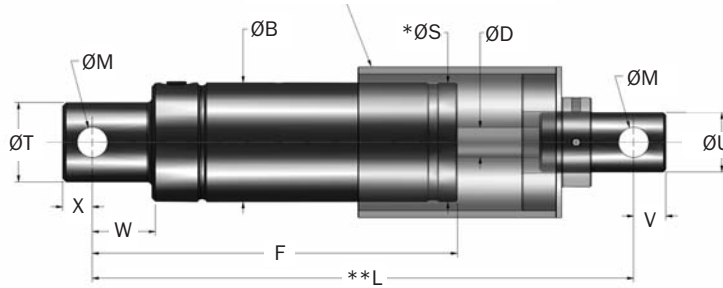

OPTIONAL PROTECTIVE SLEEVE,
TOW BAR (TB) MODELS ONLY

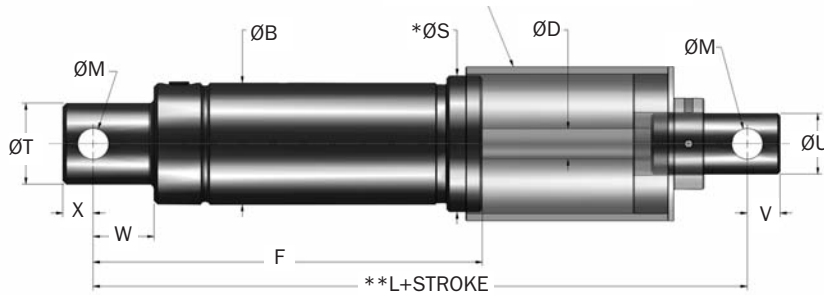

Catalog No./ Model	Damping Direction	Bore Size in. (mm)	(S) Stroke in. (mm)	(F _D) Max. Propelling Force lbs. (N)	(E _T) Max. in.-lbs./cycle (Nm/cycle)	(E _T C) Max. in.-lbs/hr (Nm/cycle)	Model Weight lbs. (Kg)
DA 75 x 6 DA 75M x 100	T, C or T and C	1.50 (38,0)	6 (150,0)	5,000 (22 250)	30,000 (3 360)	3,600,000 (406 000)	33.0 (15,0)
DA 75 x 8 DA 75M x 150	T, C or T and C	1.50 (38,0)	8 (200,0)	5,000 (22 250)	40,000 (4 480)	4,100,000 (463 000)	37.0 (16,8)
DA 75 x 10 DA 75M x 250	T, C or T and C	1.50 (38,0)	10 (250,0)	5,000 (22 250)	50,000 (5 600)	4,500,000 (508 000)	41.0 (18,6)
TB 100 x 4	T and C	2.25 (57,2)	4 (100,0)	10,000 (44 482)	40,000 (4 480)	4,400,000 (497 133)	32.0 (14,5)
TB 100 x 6	T and C	2.25 (57,2)	6 (150,0)	10,000 (44 482)	60,000 (6 779)	4,400,000 (497 133)	32.0 (14,5)

Catalog No./ Model	B in. (mm)	D in. (mm)	F in. (mm)	L in. (mm)	M ±.015 (±0,38) in. (mm)	S in. (mm)	T ±.015 (±0,38) in. (mm)	U ±.010 (±0,25) in. (mm)	V in. (mm)	W in. (mm)	X in. (mm)	(S) Stroke in. (mm)
DA 75 x 6 DA 75M x 100	3.00 (76,0)	0.75 (19,0)	13.58 (345)	17.75 (448)	.765 (19,4)	3.38 (86,0)	2.00 (51,0)	1.500 (38,0)	.81 (21,0)	1.50 (38,0)	.75 (19,0)	6 (150,0)
DA 75 x 8 DA 75M x 150	3.00 (76,0)	0.75 (19,0)	15.58 (395)	19.75 (498)	.765 (19,4)	3.38 (86,0)	2.00 (51,0)	1.500 (38,0)	.81 (21,0)	1.50 (38,0)	.75 (19,0)	8 (200,0)
DA 75 x 10 DA 75M x 250	3.00 (76,0)	0.75 (19,0)	17.58 (445)	21.75 (548)	.765 (19,4)	3.38 (86,0)	2.00 (51,0)	1.500 (38,0)	.81 (21,0)	1.50 (38,0)	.75 (19,0)	10 (250,0)
TB 100 x 4	2.75 (70,0)	1.00 (25,4)	18.88 (480)	24.25** (616)	.750 (19,1)	3.25* (82,6)	2.50 (63,5)	1.500 (38,0)	.75 (19,1)	1.75 (38,0)	.75 (19,0)	4 (100,0)
TB 100 x 6	2.75 (70,0)	1.00 (25,4)	18.88 (480)	22.25** (565)	.750 (19,1)	3.25* (82,6)	2.50 (63,5)	1.500 (38,0)	.75 (19,1)	1.75 (38,0)	.75 (19,0)	6 (150,0)

- Notes: 1. DA Models will function at 10% of their maximum rated energy per cycle. If less than 10%, a smaller model should be specified.
 2. Provide a positive stop 12 in. before end of stroke in tension and compression to prevent internal bottoming.
 3. For optimal performance in vertical applications using compression, mount the rate control with the piston rod down.
 4. * ØS indicates outside diameter of optional protective sleeve for TB models.
 5. ** Dimension L is controlled by a 2.0 in. stroke limiter.